



## Powerdrive MD2

Ready-to-use variable speed drive  
Solutions for High Power Process Applications

LEROY-SOMER™

**Nidec**  
All for dreams

# Innovative variable speed packages to reduce energy bills

## Reduction of energy costs: a challenge for the industry

The need for energy has kept increasing and has now become a worldwide concern.

Within industry it now represents more or less 30 % of the world wide energy used, mainly driven by applications linked to process typically including pumps, fans, compressors and crushers.

Currently these applications are mainly operated at fixed speed. Conversion to variable speed is a proven solution cutting energy costs by as much as 50%. The savings generated, combined with the reduction of maintenance costs and process improvements, contribute to increasing the companies' competitiveness and profitability.

## Directives and regulations: variable speed contributes to making installations compliant

In addition to the economical challenge, the reduction of energy consumption is important to the growing concern about environmental sustainability. In order to achieve the objective of reducing CO2 emissions, a series of regulations are in the process of being applied with the only objective of forcing the improvement of system energy efficiency:

- In Europe, the CE n° 640/2009 regulation relative to the ecodesign of electric motors specifies the use of motors with a minimum of IE3 efficiency level if operated fixed speed or with a minimum of IE2 efficiency levels if driven by a variable speed drive
- Other regulations are aimed at classifying the energy efficiency of complete systems based on their performance over the full operation range, rather than at nominal load. The first application where this already applies is for refrigeration compressors. It will shortly be followed by pumps, fans and air compressors.

In all cases, whatever the situation is, variable speed is a major solution allowing installations to be compliant while making significant cost savings.





### Nidec: fully committed to high energy efficient solutions

In full awareness of the challenge, Nidec has built a complete offer of motors, drives and services, fully focused on energy savings:

- **IMfinity®**: a range of induction motors available in IE2 or IE3 efficiency levels.
- **Dyneo+**: synchronous motors combining reluctance and permanent magnets with drive packages exceeding IE5 efficiency level over a wide speed range
- **Powerdrive**: range of variable speed drives designed for process applications
  - Powerdrive F300**: IP20 drives ideal for integration into cubicles
  - Powerdrive MD2**: complete IP21 or IP54 "Ready-to-use" solutions
- **Local services** for energy audits, support for selecting the most appropriate solution, installation, commissioning, maintenance servicing and 24/7 assistance for emergency situations



# Much more than energy savings using variable speed in process applications

## **Pumping (distribution, irrigation, desalinization, treatment)**

- Savings on maintenance costs when removing the flow regulation valves
- Full control of acceleration and deceleration preventing water hammers
- Leakage, pipe break or loss of prime detection
- Automatic cleaning cycle on pump clogging



## **Waste Water Treatment (agitation, bubbling, centrifugation)**

- Better oxygenation in aeration basins
- Adaptation of installation to the variable load
- Limitation of wear mainly on mechanical aerators
- Better control of sludge dewatering

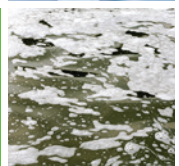

## **Refrigeration (industrial, leisure)**

- Accurate temperature control independent of outside conditions
- Significant reduction of noise when operated at partial load
- Reduction of sliding valve wear as used for starting sequence only
- Reduction of start/stop sequences

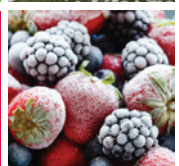

## **Ventilation (industrial, tunnels, car parks)**

- Reduction of maintenance costs on flow adjustment louvers
- Detection of transmission belt breakage
- Accurate speed adjustment to temperature, humidity and pollution
- Control of smoke stratification in tunnels and car parks during fires

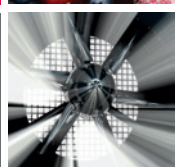

## **Crushing (pet food, wood, quarrying)**

- Controlled and faster deceleration
- Better crushing quality with less screen changes
- Possibility of high starting torque when replacing a slip ring motor
- Speed slaving of peripheral equipment to optimize complete process

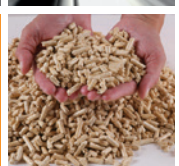





The retrofit of an installation or the conversion from fixed speed to variable speed of a system requires various arrangements like fitting the drive in an existing environment, handling the power wiring or interfacing the controls with other equipment. The difficulty of addressing all of this is more important as the power is high, where the solution needs to be flexible enough so it contributes to keeping the investment costs down.

### Powerdrive MD2: THE all inclusive ready-to-use solution !

Thanks to our strong experience resulting from close partnerships with end users and OEMs, Nidec is offering Powerdrive MD2, in line with the expectations of the major players in the process market segment:

- **Ready-to-use:** everything needed is fitted, wired and tested
- **Compact and robust:** easy and flexible integration in an electrical room as well as in a machine environment
- **Protected:** outstanding level of protection against electrical disturbances
- **Simple:** commissioning and operation without any specific skills
- **Serviceable:** high level of reliability, preventive diagnostics and modularity for minimum downtime



# A complete system engineered, wired and tested Powerdrive MD2 is ready-to-use !

The integration of a variable speed drive in a system requires engineering, component sourcing, fitting and wiring, as well as testing.

The Powerdrive MD2 has been set-up so it provides a complete system including all equipment needed for protecting, controlling, interfacing and running the application with full safety.

## Line interrupter with lockable front handle

Option fitted and wired, allowing motor isolation from the power supply for safe maintenance.

## Safe Torque Off (STO) inputs

No need for a contactor between the drive and motor thanks to certified STO inputs. Complies with IEC/EN 62061:2005 and EN/ISO 13849-1:2006, using single channel disable (SIL1 or PLb) or double channel disable (SIL3 or Plc).

## Emergency push button

Located on drive front cover the Emergency push button is wired on the STO input.

## Line reactor

Fitted as a standard. Provides additional protection against line disturbances and reduces harmonic distortion levels by 25% compared to a design using a DC choke.

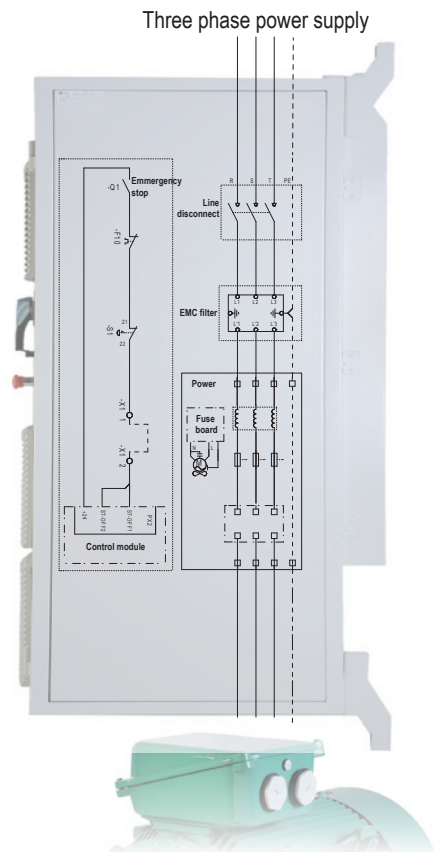





## PLC function blocks

Available as standard, these function blocks allow saving automation components when application specific logic is required:

- Automatic pump cleaning sequence upon clogging detection
- Maximum speed reached alarm for launching fixed speed motor starting
- Initiate an emergency action upon detection of motor transmission break
- Delay one event from another
- Generate an alarm when a defined operating time is reached in order to plan the maintenance
- Load sharing between multiple machines on high temperature in order to prevent unexpected trips

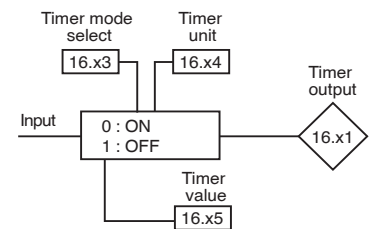
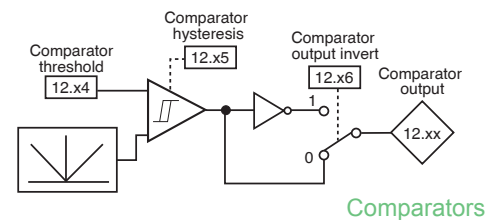

## High speed fuses

Fitted as a standard. Provide additional short circuit protection complementary to internal drive protections.

## Automated fans

Option wired and set-up. Allows switching the drive fans off in order to save energy, reduce noise level and limit wear.

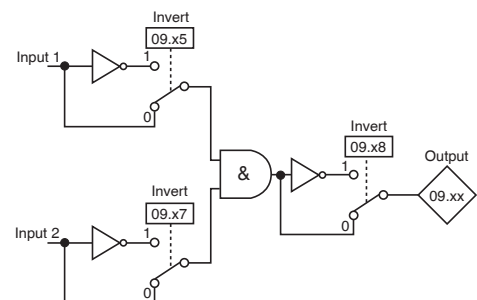

# Compact and robust Powerdrive MD2 can be fitted anywhere

Finding a suitable space to add the drive to an installation, especially when it is a high power, may not be so easy. The resistance to the environment, protection of personnel, mounting flexibility, EMC management, mechanical robustness are major considerations which have been taken into account while designing the Powerdrive MD2.

## Powerdrive MD2: A complete solution in a compact size

Up to 250 kW, Powerdrive MD2M, all inclusive, is available in a wall mount version. In addition to its compactness, it provides great flexibility in terms of mounting arrangements:

- A direct fit on a wall in the machine environment
- A mounting on a chassis in an electrical room
- The possibility to stand on the floor sitting on a 400 mm stainless steel base. This allows close fitting to the motor in a humid environment without any need for a trench in the floor.

Above 250 kW, Powerdrive MD2S is available in a free standing cabinet limited to 600 mm width for 500 kW, or 1200 mm for 900 kW.

## No compromise on accessibility

Very often, compactness is achieved at the expense of accessibility. Powerdrive MD2 has been designed with a focus on entering multiple large cables, and running them inside with easy connections. Once the drive has been wired up, all components remain easy to reach.







## IP21 design for clean environments or IP 54 for harsh conditions

Whatever the conditions are, Powerdrive MD2 provides a panel of equipment and features aimed to fully protect the drive and its components.

- Filter clogging detection by internal temperature monitoring and analysis (programmable)
- Conformal coated circuit boards and tropicalized line reactor and transformers
- Tin plated copper power bus bars
- Thermally treated epoxy paint
- Optional thermostated heater for humid environments or seasonal use

## Installation close to the motor: reducing EMC emissions at lowest cost

Powerdrive MD2's mechanical and electrical robustness allows close fitting to the motor, with drive-to-motor cable length reduction leading to economical and technical advantages like:

- Significant cost reduction of shielded cables
- Lower EMC emissions, current leakages and bearing currents
- Limitation of motor voltage drop

## Outstanding thermal behavior

The robust design of Powerdrive MD2 allows for operation in a range ambient conditions and unusual temperatures:

- **Operation at 50°C ambient** permanently with adapted sizing
- **Operation at 70°C for 1 hour** in exceptional circumstances like smoke extraction in public buildings



## Fire Mode



When operating conditions limits are exceeded, the drive trips to protect itself. However, there are certain emergency situations where the drive must run whatever the conditions are (smoke extraction fans in tunnels, car parks and fire pumps). Powerdrive MD2 allows for the disabling of all internal protection forcing the drive to provide full availability without tripping (run command, direction selection and speed reference can be specific to the fire mode).

# Simple and user friendly

## To facilitate commissioning and operation

Operating a drive during its life time requires different levels of access. Each of them with specific needs:

- Simple and quick set-up during drive commissioning
- Saving the settings in order to easily and quickly duplicate while guarantying repeatability
- Displaying the operating data for running the application efficiently
- Generating clear alarms prior to tripping or on programmable conditions
- Providing diagnostic tools after a trip will allow quick and safe restarting

### User friendly interface

The 4.3 " color screen touch pad of Powerdrive MD2 is the key to providing a simple and user friendly answer to the varying expectations of the different people using this type of equipment.



**Information mode:** access to drive characteristics, operating time or language selection

**Setting mode:**

- Quick set-up through 5 interactive sub menus.
- Advanced setting with access to all drive parameters (code protected)
- Saving of 3 complete sets of parameters (time stamped files)

**Read mode:** Display of drive status and main operating data: Power supply, DC bus and motor voltage, current, speed, power and temperatures, etc

**Keypad control mode:** Allows operating the drive through the keypad. Can be used for application tuning without modifying the controls

**Trip history mode:** Access to the last 10 trips with time stamping





## Easy and direct access to drive data

As the skills of people authorized to set-up a drive may be different to those authorized to enter into electrical equipment, Powerdrive MD2 provides full access to the controls through a USB port located on the front panel.

This USB port allows a laptop to communicate with the drive without powering-up the drive. The Nidec MDX-SOFT commissioning software, which can be downloaded from the web for free, provides a number of features like:

- **Drive setting** by downloading an existing parameter file or by using simplified interactive macros or advanced menus
- **Firmware upgrade** in order for the operator to take benefit of the latest improvements
- **Parameter comparison** to detect deviations between 2 parameter files which could explain abnormal behavior
- **Scope feature** for supervising up to 4 programmable channels with a 125  $\mu$ s minimum sampling time

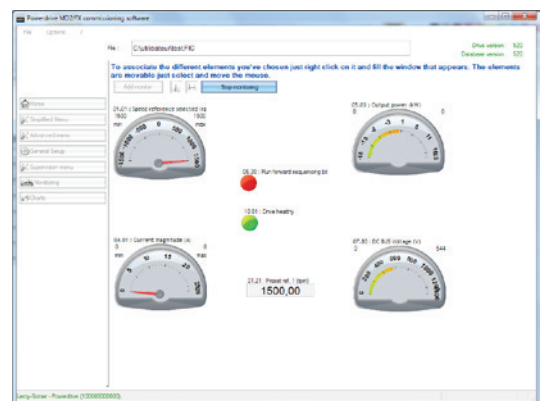

Parameter	Name	Value	Default	Unit
Ch01	factory settings (R143)	0 - Disabled		
Ch02	User drive mode (R121)	1 - Induction motor in open loop mode		
Ch03	Switching frequency (R119)	2 - 3 kHz		
Ch04	Inverter current limit (R147)	100.0 %		%
Ch05	Runstop source (R145)	0 - Terminal inputs		
Ch06	Start stop sign select (R148)	3 - Controlled run (the fault)		
Ch07	Signal reference enable (R118)	0 - No		
Ch08	Stop mode (R141)	1 - Pump		
Ch09	Lock a starting motor (R149)	0 - Disabled		
Ch10	Signal open mode (R142)	0 - Disabled		
Ch11	Auto reset time (R140)	0 - Controlled		
Ch12	Reverse direction (R146)	0 - Checked		
Ch13	Open stop mode selection (R114)	4 - No measured after each power up		
Ch14	Autotune (R112)	0 - No		



# High level of reliability and serviceability Essential for critical process applications

For process applications, the benefits of variable speed are greater as the power is high, especially generating energy savings. Consequently, the ideal applications are those located upstream in the process, very often critical for operations. In order to guarantee the level of availability requested, Powerdrive MD2 offers outstanding innovative features aimed at minimizing potential downtimes.

## Preventive auto-test

On request, at each power-up or at each start, a preventive auto-test of the main components is carried under low voltage.

This test is performed on power components (rectifier, inverter, current transformers, etc...) as well as on electronic printed circuit boards and on motor line (potential short circuit detection).

In the event of a fault condition, Powerdrive MD2 clearly indicates the component involved.

## Diagnostic

Logging the main operating data in a buffer and freezing the values prior to a drive trip allows easy and quick diagnostic of the trip root cause

- DC bus and power supply voltage, motor speed and current, temperatures, etc...
- Up to 17 instantaneous values for all data with 125 $\mu$ s to 4ms sampling time
- Average and maximum values

## Onboard data logger

The only way of catching events responsible for spurious installation trips generally consists in temporarily fitting expensive recording equipment. An option module, fitted on Powerdrive MD2, can log up to 10 parameters with a minimum sampling time of 20 ms on an SD card. The 4 Go SD card supplied with the option module allows recording over 2 weeks (10 parameters at 20 ms sampling time).

Data is time stamped and logged in a .csv file that can be retrieved by a PC.





### Easy access to facilitate maintenance

Powerdrive MD2 is the result of a combination of standard small and light components (rectifier module, inverter modules, electronic PCBs, forced ventilation, etc..) with all of them being accessible and interchangeable using basic tooling (heaviest component < 15 kg).

This outstanding modular design makes Powerdrive MD2 extremely simple and quick to restart.

### Reduced spare part inventory

As a result of the modular design, the full Powerdrive MD2 range only requires a small number of individual replacement parts, reducing the diversity and cost of spare parts inventory.

For instance from 160 kW to 2,800 kW :

- 1 unique control board
- 2 parts for forced ventilation
- 4 parts for the rectifier module
- 7 parts for inverter modules

Whatever the installed base is, the limited requirement of spare parts helps to keep an inventory which leads to a quick restart of all installations.



# Motor & drive packages

## The guaranty of optimum performance

Whether it is to comply with new efficiency regulations or benefit from the highest energy efficiency solution, Nidec offers complete packages optimized and tested to work together providing the highest level of performance.

### **IMfinity®: new high or premium efficiency induction motor platform**

Available in IE2 and IE3, the IMfinity® range has been designed and qualified for use at fixed speed on a multi-voltage/multi-frequency power supply or at variable speed using a drive.

All motor and drive package performance at different operating levels have been fully tested allowing optimized sizing while guaranteeing safe operation

### **Dyneo+: sensorless reluctance & permanent magnet motor**

The combination of 15 years experience in synchronous control motor and of a tight collaboration between our motor and drive design teams have led to the development of outstanding PM solutions, aimed at providing the full and safe control of the majority of process applications in sensorless mode including pumps, compressors, blowers, aerators, centrifuges and fans. This provides the highest level of PM technology performance with the simplicity of operating induction motors.

### **Global manufacturer's warranty**

The perfect match of a motor and drive package supplied by a single manufacturer is the insurance of getting the highest level of performance from components designed to work together with one single contact for support.









## Powerdrive MD2 : ready-to-use drive solutions

### ■ 5 days express availability offer up to 500 kW/800 hp

- IP21 or IP54 drive
- 6 pulse rectifier
- 380 V to 460 V power supply

Standard options fitted and wired ready-to-use

- Line interrupter
- C2 EMC filter
- Heater
- Emergency push button
- Bases
- Option modules: fieldbus (Profibus DP V1, Modbus RTU, Ethernet TCP/IP and CANopen), I/O extension, encoder
- Automated fans



	Power rating				Powerdrive type	Dimensions (mm/in)		
	Normal duty		Heavy duty			H	W	D
	kW	hp	kW	hp				
Wall mount	55	75	45	60	MD2MS 60T	1203/47.4	480/18.9	516/20.3
	75	100	55	75	MD2MS 75T			
	90	125	75	100	MD2MS 100T			
	110	150	90	125	MD2MS 120T			
	132	200	110	150	MD2MS 150T			
	160	250	132	200	MD2MS 180T			
	200	300	160	250	MD2MS 220T			
250	400	200	300	MD2MS 270T				
Free standing	315	450	250	400	MD2S 340T	IP21	600/23.6	600/23.6
	355	500	315	450	MD2S 400T	2100/82.7		
	450	700	355	500	MD2S 470T	IP54		
	500	800	400	600	MD2S 570T	2200/86.6		

### ■ Standard expanded offer

- Free Standing solution below 250 kW/300 hp (alternative to wall mount)
- Paralleled IP 21/IP54 chassis for powers up to 1,600 kW/2,000 hp
- 690V power supplies, 200 to 1,600 kW/300 to 2,000 hp
- Liquid cooling, 132 to 1,600 kW/200 to 2,000 hp
- Active Front End, 45 to 1,600 kW/60 to 2,000 hp
- Wider choice of options: data logger, braking chopper, auxiliary motors control, temperature relays...



Power range

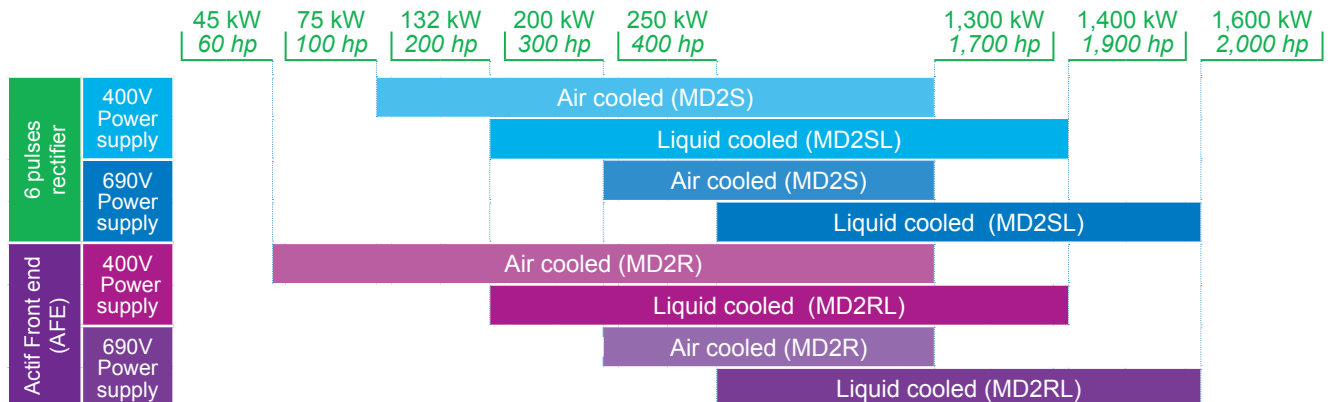

## ■ Customized solutions

- 45 to 2,800 kW
- Special cubicles (stainless steel, double skin, etc),
- Adapted mechanics (back-to-back cells instead of inline, limited height )
- 12, 18 or 24 pulse rectifiers
- Engineering, manufacturing and testing (possibility of certification by notified body) on specification



## Powerdrive F300 : IP20 AC drives for integration in cabinets

Flexible drive, easily adaptable to your particular application requirements

- 1,1 to 2,800 kW
- 6, 12 and 18 pulses and AFE
- PLC functionality
- Easy and flexible panel mounting



## Dyneo+ range : general purpose magnet-assisted synchronous reluctance motors

Premium efficiency PM synchronous motor with drive

- 3 to 500 kW
- 315 to 5 500 rpm
- IP55 or IP23
- Efficiency exceeding IE5 level



## IMfinity® and LS range : general purpose asynchronous motors

High and premium efficiency motors for fixed and variable speed

- 0,08 to 1,500 kW
- IP55 or IP23
- Cast iron or cast aluminium housing
- Non IE, IE2, IE3, IE4 derivative ranges (Atex, Nuclear, High temperature, liquid cooled, and customized versions)





# Comprehensive and customized local services with round-the-clock support



Along with comprehensive training, our global Automation Centers provide a range of local services tailored to meet your expanding productivity, performance and process safety needs. This includes:

- Analysis of current installations to detect areas for improving processes and reducing energy consumption
- Highly skilled system design to create innovative and energy saving solutions
- Dedicated all hours technical support
- Maintenance servicing to ensure maximum performance and trouble-free operation for the lifetime of the system
- Guaranteed rapid response to emergency situations

## Audit and consultation

Our auditing services are designed to analyse your existing application and processes to identify opportunities for improving performance, energy efficiency and the lifetime of equipment. This could result in retrofitting equipment or an entire system upgrade. We provide an evaluation of return on investment (ROI), helping to justify initial outlay.

## Optimizing energy savings and payback

Once potential energy savings have been identified, we commit to calculated payback periods, while obtaining the Energy Saving Certificates your business requires. We will also provide a high yield installation and maintenance schedule to ensure optimum performance is maintained through the lifetime of your equipment.



## Retrofit and system upgrades

Where required, existing hardware is retrofitted quickly and easily, reducing downtime and investment. Alternatively we can produce high performance solutions to upgrade your production processes, improving productivity. A dedicated team takes care of the whole project implementation, along with training and maintenance schedules.

## Installation and commissioning

Our objective is to ensure the reliability and safety of your equipment for optimum longevity:

- Our accredited personnel ensure systems are installed in compliance with local technical regulations and safety standards
- Our world class onsite commissioning ensures systems are set-up thoroughly and rapidly
- Extended system guarantees of up to 48 months are available

## Maintenance

All our maintenance policies, whether emergency or scheduled, are designed to meet your specific requirements, minimizing disruption and downtime to your operation.

- Emergency services include 24/7 telephone and web support, onsite technical assistance, express round-the-clock delivery of products & spare parts and urgent repairs.
- For ongoing maintenance work, we can manage product replacements, retrofits and upgrades rapidly through our assembly centres
- Maintenance contracts are available to ensure the proper running of your equipment

Services are optimized on a country-by-country basis, so please contact your local sales contact for full details of our local offering.



**LEROY-SOMER**<sup>™</sup>

[www.leroy-somer.com](http://www.leroy-somer.com)

**Connect with us at:**

[twitter.com/Leroy\\_Somer\\_en](https://twitter.com/Leroy_Somer_en)

[facebook.com/leroy-somer.nidec.en](https://facebook.com/leroy-somer.nidec.en)

[youtube.com/user/LeroySomerOfficiel](https://youtube.com/user/LeroySomerOfficiel)

[linkedin.com/company/44575](https://linkedin.com/company/44575)



**Nidec**  
All for dreams

© 2019 Moteurs Leroy-Somer SAS. The information contained in this brochure is for guidance only and does not form part of any contract. The accuracy cannot be guaranteed as Moteurs Leroy-Somer SAS have an ongoing process of development and reserve the right to change the specification of their products without notice.

Moteurs Leroy-Somer SAS. Headquarters: Bd Marcellin Leroy, CS 10015, 16915 Angoulême Cedex 9, France. Share Capital: 65 800 512 €, RCS Angoulême 338 567 258.



Distributor

**LEROY-SOMER**<sup>TM</sup>

<https://motorielettrici.elleuno.eu>

[info@elleuno.eu](mailto:info@elleuno.eu)

Phone +39 028131848

Fax +39 0289190444

ELLEUNO s.r.l.

Via Bari 24 20143 MILANO Italy